



## **INNOVATIONS IN EARTHQUAKE RESISTANT STEEL STRUCTURES**

M. Bruneau<sup>1</sup>

### **ABSTRACT**

This paper reviews selected recent innovations that expand the range of applicability of a number of new and emerging structural steel systems that can provide effective seismic performance. Focus is on recent developments on: (a) Steel Plate Shear Walls having light gauge infill plates; (b) Perforated Steel Plate Shear Walls; (c) Buckling Restrained Braced frames designed to meet Structural Fuse objectives; (d) Tubular Eccentrically Braced Frames, and; (e) Rocking braced frames.

### **Introduction**

A recently published paper has provided a brief review of selected recent work on the development of solutions for the seismic design and retrofit of steel structures by various members of the U.S. research community (Bruneau et al. 2005). That previous paper focused on research on Retrofit of Beam-to-Column Moment Connections, Frame Modifications at Beams' Mid-Span, Self-Centering Systems, Zipper Frames, Buckling-Restrained Braced Frames, Steel Plate Shear Walls, Plastic and Rotation Limits for Buildings and on Shear Links and Truss Piers for Bridges. That research has resulted on the development of valuable concepts for enhancing the seismic performance of steel structures.

Here, information is presented on selected subset of recent innovations that expand the range of applicability of some emerging systems that have seen a significant increase in interest by the practicing engineering community over the past few years. In a first part, this paper focuses on Steel Plate Shear Walls (SPSW) designed to rely on the development of diagonal tension yielding for seismic energy dissipation, and Buckling Restrained Braces (BRB) which are special braces that can develop their full axial yield strength both in tension and compression. SPSW were first proposed by Canadian researchers and the Canadian standard "Limit States Design of Steel Structures" (CSA 2001) was first to implement specific seismic design provisions for this system. BRB were originally developed by Japanese researchers in the early 1980's, and North American requirements for their design were first specified by the "Seismic Provisions for Structural Steel Buildings" of the American Institute of Steel Construction (AISC 2005). Both SPSW and BEB are highly ductile systems that make it possible to design structures with high lateral stiffness, thus indirectly limiting some of the non-structural damage that can be suffered during earthquakes. Passage of the California Senate Bill 1953 that mandates that all health care facilities providing acute care services be retrofitted to a life-safety performance level by 2008, and a full-serviceability level by 2030, has partly played an important role in raising awareness that extensive non-structural damage is undesirable and detrimental, as it can render buildings unusable for

---

<sup>1</sup>Director, MCEER, and Professor, Department of Civil, Structural, and Environmental Engineering, University at Buffalo, Buffalo, NY 14260

extended periods of time following earthquakes.

A latter part of the paper focuses on innovations recently developed as design strategies for large steel bridges, but that can also have important applications in buildings. Important seismic evaluation and retrofit of major crossings have occurred in North America since a span of the San Francisco–Oakland Bay Bridge collapsed during the 1989 Loma Prieta earthquake. Large steel truss bridges were evaluated and in some cases retrofitted in most states where these important lifelines exist, including California, Washington, Oregon, New York, and the Mid-West States. The systems described here would be applicable for these types of retrofit as well as for new designs.

### **Steel Plate Shear Walls**

The selection of SPSW as the primary lateral force resisting system in buildings has increased in recent years as design engineers discover the benefits of this option. Its use has matured since initial designs, which did not allow for utilization of the post-buckling strength, but only elastic and shear yield plate behavior. Research conducted by Thorburn et al. (1983), Lubell et al (2000), Driver et al. (1997), Caccese et al (1993), Berman and Bruneau (2003b, 2004) (among many) supported the SPSW design philosophy that reduced plate thickness by allowing the occurrence of shear buckling. After buckling, the lateral load is carried in the panel via the subsequently developed diagonal tension field action. Smaller panel thicknesses also reduce forces on adjacent members, resulting in more efficient framing designs. Understanding of the seismic behavior of thin plate SPSW has significantly improved in recent years. Yet, some obstacles still exist that may impede further widespread acceptance of this system. For example, using the yield stress for typically available steel material, the panel thickness as required by a given design situation may often be much thinner than the minimum hot rolled steel plate thickness typically available from steel mills. In the perspective of capacity design, this will increase the necessary sizes of horizontal and vertical boundary members as well as foundation demands. To alleviate this concern, recent work has focused on the use of light-gauge cold-rolled and low yield strength (LYS) steel for the infill panel (Berman and Bruneau 2003b, Vian and Bruneau 2004), and also by placement of a pattern of perforations to decrease the strength and stiffness of the panel by a desired amount (Vian and Bruneau 2004). In addition, the use of reduced beam sections at the ends of the horizontal boundary members is being investigated as a means of reducing the overall system demand on the vertical boundary members (Vian and Bruneau 2004). These efforts are briefly summarized below:

#### **SPSW with Light-Gauge Infill**

A SPSW test specimen utilizing a light-gauge infill (thickness of 1.0 mm, 0.0396 in) is shown in Fig. 1 (Berman and Bruneau 2003b). The specimen used W 310 x 143 (US - W 12 x 96) columns and W 460 x 128 (US - W 12 x 86) beams. This test was performed using quasi-static cyclic loading conforming the recommended Applied Technology Council (ATC) loading protocol of ATC 24 (ATC 1992). Hysteretic results are shown Fig. 2 along with the boundary frame contribution. After subtracting the boundary frame contribution, the hysteresis of Fig. 3 is obtained. This specimen reached a ductility ratio of 12 and drift of 3.7%, and the infill was found to provide approximately 90% of the initial stiffness of the system. Ultimate failure of the specimen was due to fractures in the infill propagating from the welds which connected it to the boundary frame. Figs. 4a and 4b show the buckling of the infill plate at the peak displacement of cycle 20 (ductility ratio of 6, 1.82% drift) and the fracture at the infill corner during cycle 26 (ductility ratio of 10, 3.07% drift) respectively.

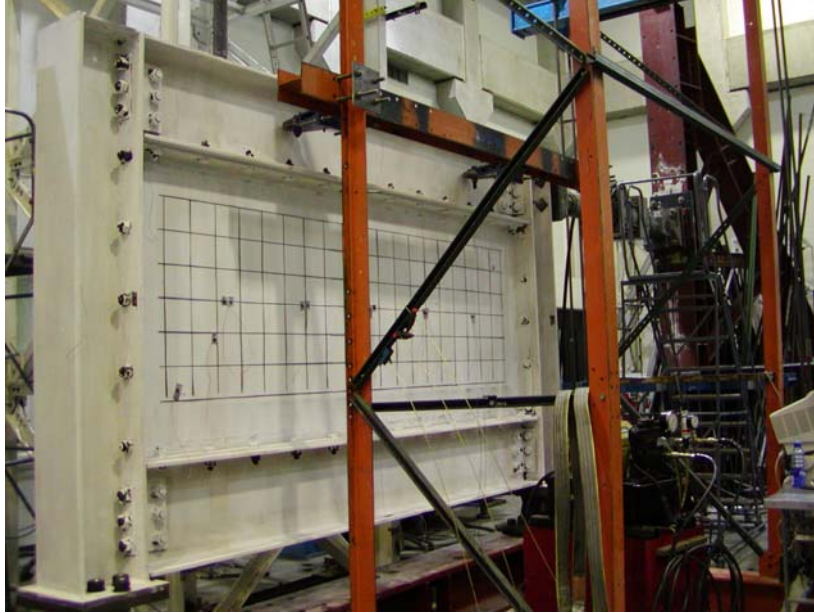

Figure 1. Light-Gauge SPSW Prior to Testing (Berman and Bruneau 2003b).

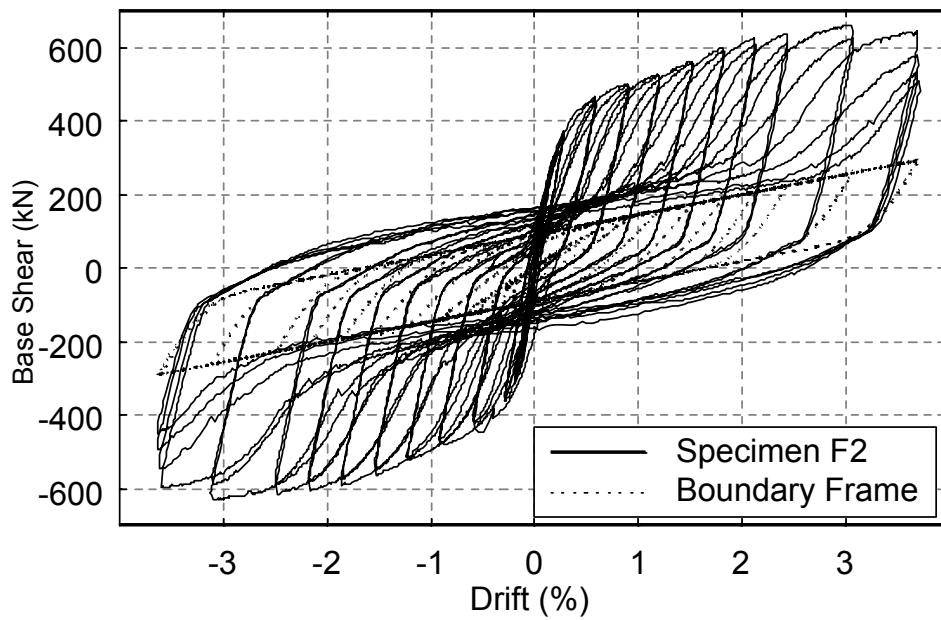

Figure 2. Light-Gauge SPSW and Boundary Frame Hystereses (Berman and Bruneau 2003b).

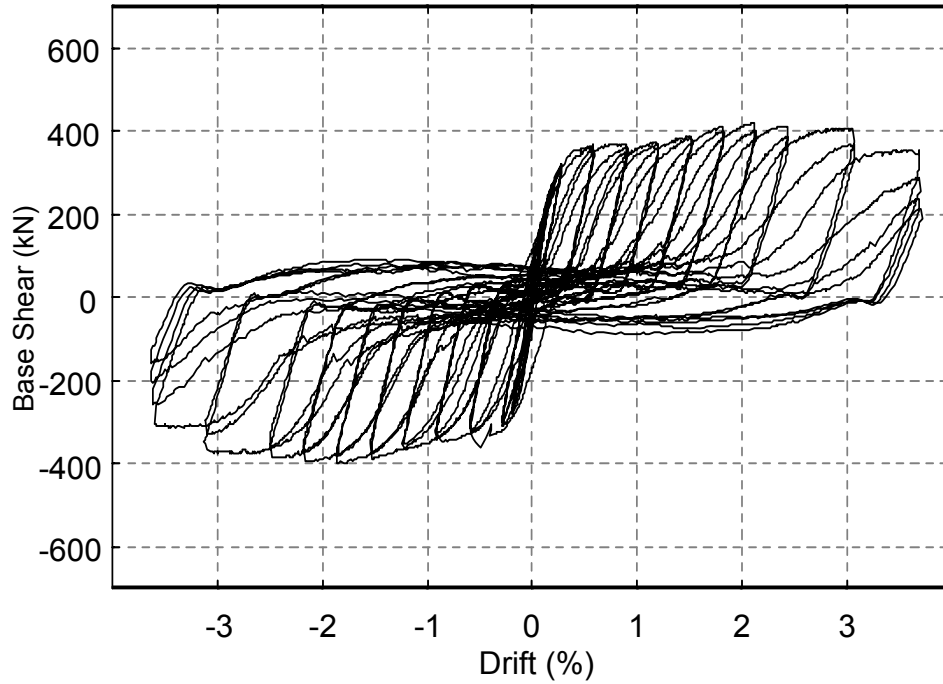

Figure 3. Light-Gauge SPSW Hystereses – Infill Only (Berman and Bruneau 2003b).



(a)

(b)

Figure 4. (a) Buckling of Infill at 1.82% Drift; (b) Fracture of Infill Corner at 3.07% Drift (Berman and Bruneau 2003b).

### Special Perforated SPSW

Vian and Bruneau (2004) investigated the seismic performance of SPSW designed and fabricated using low yield strength (LYS) steel panels and Reduced Beam Sections (RBS) added to the beam ends in order to force all inelastic action in the beams to those locations (Fig. 5). It was felt that this would also promote increasingly efficient designs of the “anchor beams,” defined as the top and bottom beams in a



multistory frame, which “anchor” the tension field forces of the SPSW infill panel.

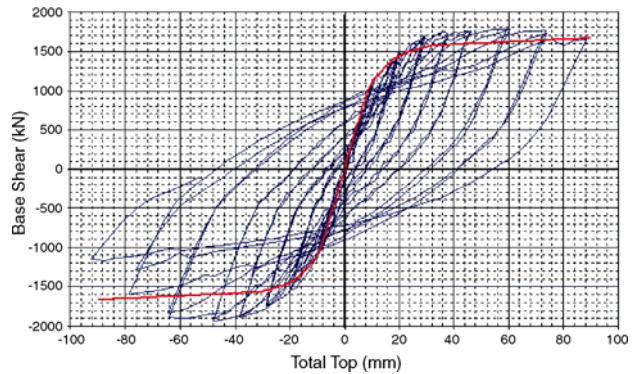
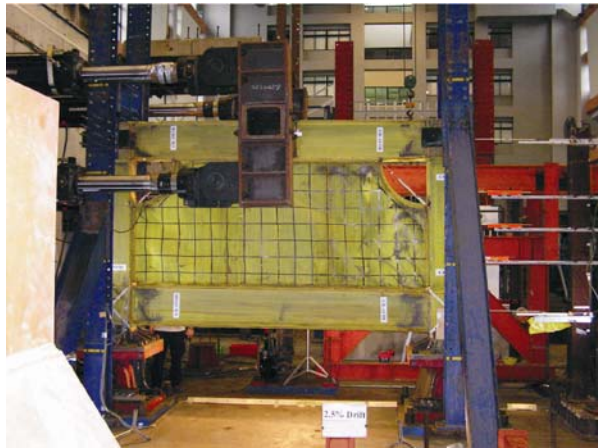

Figure 5. SPSW Specimen with Cutout Corners (right) and Typical Hysteresis Loops for Solid Wall Specimen (Vian and Bruneau 2004).

SPSW with low yield steel webs appear to be a viable option for use in resistance of lateral loads imparted during seismic excitation. The lower yield strength and thickness of the tested plates result in a reduced stiffness and earlier onset of energy dissipation by the panel as compared to conventional hot-rolled plate. The perforated panel specimen shows promise towards alleviating stiffness and over-strength concerns using conventional hot-rolled plates. This option also provides access for utilities to penetrate the system, important in a retrofit situation, in which building use is pre-determined prior to SPSW implementation. The reduced beam section details in the beams performed as designed, as shown in Fig. 6. Use of this detail may result in more economical designs for beams “anchoring” an SPSW system at the top and bottom of a multi-story frame. On-going research is focusing on developing reliable models that can capture the experimentally observed behavior, and investigating the benefits of this system on enhancing the seismic performance of nonstructural components.

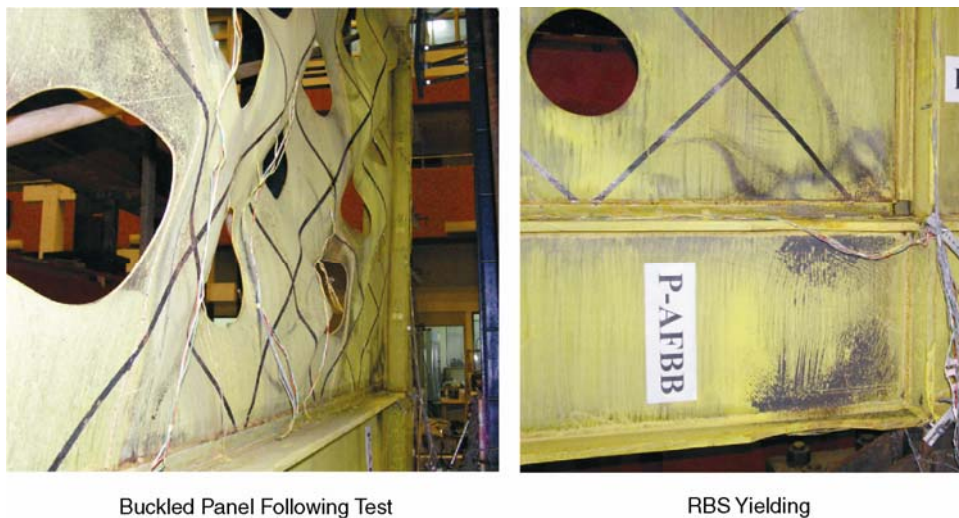

Figure 6. Buckled Panel and RBS Yielding of SPW Specimen (Vian and Bruneau 2004).

## Other Recent Developments on SPSW

A number of other important issues for the design of SPSW have also received attention recently. First, recent work (Berman and Bruneau 2003a) has illustrated how plastic design can be used to assess the ultimate capacity of SPSW and prevent undesirable local story-failure modes. Second, to resolve uncertainties regarding the seismic behavior and design of intermediate beams in SPSW (intermediate beams are those to which are welded steel plates above and below, by opposition to top and bottom beams that have steel plates on only below or above respectively), and expand on a limited investigation of this problem by Lopez-Garcia and Bruneau (2006) using simple models, an experimental program was developed to test a two-story SPSW having intermediate composite beams with RBS connections. The testing program also investigated how to replace a steel panel after a severe earthquake and how the repaired SPSW would behave in a second earthquake. Another paper presented at this same conference paper (reference) summarizes the tests conducted, observed ultimate behavior, and describes the adequacy of simple models to replicate the global behavior of the SPSW considered. These results will therefore not be repeated here.

## Buckling-Restrained Braced Frames

Buckling-restrained braced (BRB) frames have received much attention in recent years in the U.S., and other authors have extensively covered the latest research and knowledge on this topic (Sabelli et al. 2003, Uang and Nakashima 2003). Design requirements for BRB frames are easily accessible (AISC 2005), even though at this time, most BRB systems are proprietary (as a result, testing of components and representative sub-assemblies are typically required). Many uniaxial tests of diverse types of BRBs have been conducted to date, consistently exhibiting stable hysteresis behavior (with full hysteresis loops) and excellent low-cycle fatigue life. Limited subassembly test results have showed some undesirable failure modes, typically due to buckling and cracking of gusset plates. However, it was observed in those cases that similar failures would have occurred in all types of braced frames pushed to the same displacement histories (López et al. 2002), highlighting the limited knowledge and significant need for further research on the behavior of braced frames (with their surrounding frames) in general.

Recent research looked at ways to use BRB frames as part of a structural fuse concept that would limit damage to disposable structural elements for any general structure, without the need for complex analyses. A systematic and simplified design procedure to achieve and implement such a concept was proposed by Vargas and Bruneau (2006a). The proposed structural fuse design procedure for multi-degree-of-freedom (MDOF) structures relies on results of a parametric study, considering the behavior of nonlinear single degree of freedom (SDOF) systems subjected to synthetic ground motions. Nonlinear dynamic response is presented in dimensionless charts normalized with respect to key parameters. Allowable story drift is introduced as an upper bound limit in the design process.

Figure 7 shows a general pushover curve for a SDOF structure, in which frame and metallic fuses system are represented by elasto-plastic springs acting in parallel. The total curve is tri-linear with the initial stiffness,  $K_1$ , calculated by adding the stiffness of the frame and the fuses system,  $K_f$  and  $K_a$ , respectively. Once the fuses system reaches its yield deformation,  $\Delta_{ya}$ , the increment on the lateral force is resisted only by the bare frame, being the second slope of the total curve equal to the frame stiffness,  $K_f$ . Two defining parameters used in this study are obtained from Fig. 7: the post-yielding stiffness ratio,  $\alpha$ , and the maximum displacement ductility,  $\mu_{max}$ . In Fig. 7,  $V_{yf}$  and  $V_{yd}$  are the base shear capacity of the bare frame and the fuses system, respectively; and  $V_y$  and  $V_p$  are the total system yield strength and base shear capacity, respectively.

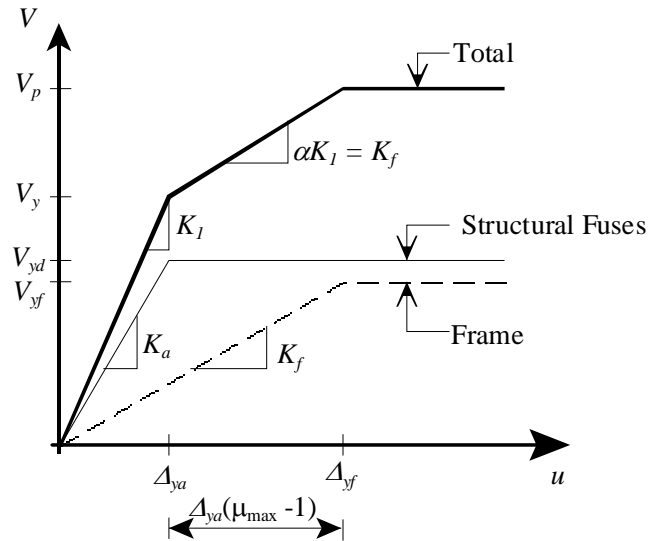

Figure 7. General Pushover Curve (Vargas and Bruneau 2006a).

Examples of frames designed following this procedure are presented in Vargas and Bruneau (2006a) using transverse moment-resisting frames from the four-story MCEER Demonstration Hospital (Yang and Whittaker 2002), using BRBs as metallic fuses. Intermediate values of  $\alpha = 0.25$  and  $\mu_{\max} = 5$  are typically used in those example to satisfy capacity design principles and yet provide adequate ductility. Seismic response of the resulting designed systems is then evaluated by nonlinear time history analysis to verify that the structural fuse concept is fully satisfied. Figure 8 shows the maximum response in terms of hysteresis loops of beams and BRBs at each story. Beams respond elastically, while hysteretic energy is dissipated by inelastic behavior of the BRB at every story. A maximum roof displacement of 155 mm was obtained from the analysis, which corresponds to a frame ductility of 0.85 (i.e.,  $\mu_r < 1.0$ ). Further information and other examples of application can be found in Vargas and Bruneau (2006a).

As a proof of concept to the developed design procedure, a three-story frame was designed and subjected to shake-table testing (Fig. 9a) (Vargas and Bruneau 2006b). One of the main purposes of the structural fuse concept being to concentrate seismically induced damage on disposable elements, this experimental project assessed the replaceability of BRB designed as sacrificeable and easy-to-repair members. BRB replaceability was examined in a test-assessment-replacement-test sequence. BRB were also connected to the frame using removable and eccentric gusset plates (Fig. 9b), especially designed to prevent performance problems observed in previous experimental research (Tsai et al. 2004, Mahin et al. 2004, and Uriz 2005). Design and behavior of this type of connection was also investigated in this experimental project. Another objective of this test was to examine the use of seismic isolation devices to protect nonstructural components from severe floor vibrations. For demonstration purpose, the seismic isolation device selected consisted of a bearing with a spherical ball rolling in conical steel plates, a.k.a. Ball-in-Cone (BNC) system. This type of seismic isolator was installed on the top floor of the frame model, and its response in terms of acceleration and displacement was investigated.

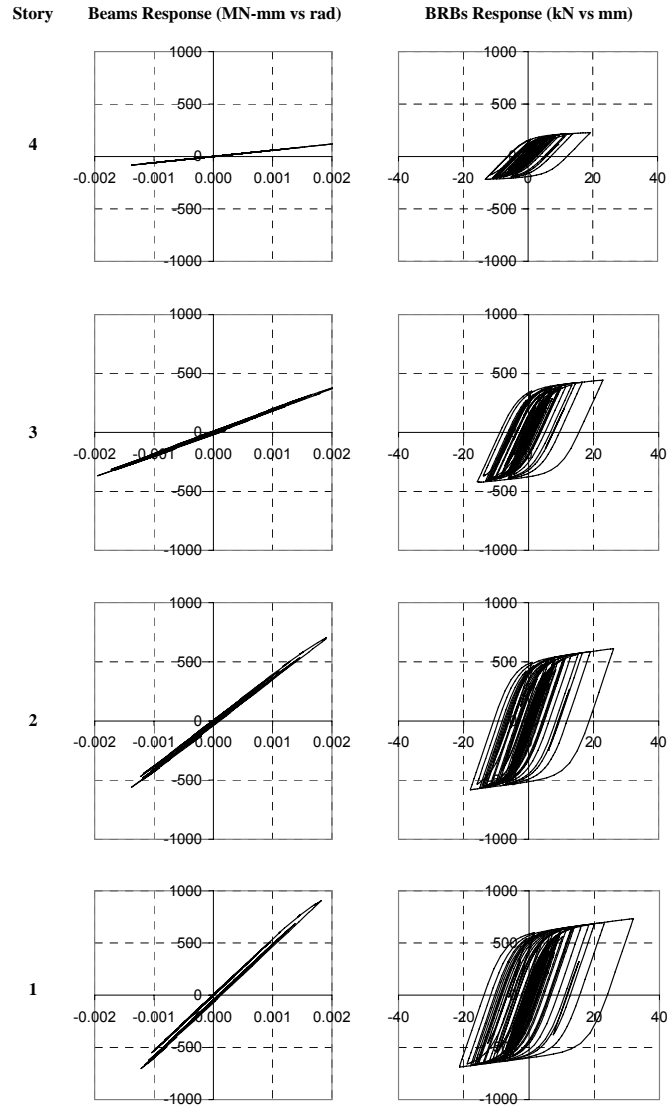

Figure 8. Hysteresis Loops from Design Example (Vargas and Bruneau 2006a).

In all tests, seismically induced yielding was successfully concentrated in the BRB, as intended. Replaceability of the BRB was also accomplished successfully 3 times, using four different sets of braces connected to the frame. The removable eccentric gusset-plate also exhibited good performance, and did not experience local or out-of-plane buckling. Similarly, the BNC isolators were observed to be effective to control the acceleration transmitted to nonstructural components in structural fuse systems. Furthermore, good agreement was generally observed between experimental results and seismic response predicted through analytical models. Further information and other examples of application can be found in Vargas and Bruneau (2006a; 2006b).





Figure 9. (a) Three-story Shake-Table Test Specimen; (b) removable and eccentric gusset plates (Vargas and Bruneau 2006b).

### Tubular Eccentrically Braced Frames

Eccentrically braced frames (EBF's), which rely on yielding of a link beam between eccentric braces, have been shown to provide ductility and energy dissipation under seismic loading (Roeder and Popov 1978a, Roeder and Popov 1978b, Popov and Bertero 1980, Hjelmstad and Popov 1983, Hjelmstad and Popov 1984, Malley and Popov 1984, Kasai and Popov 1986a, Kasai and Popov 1986b, Ricles and Popov 1989, and Engelhardt and Popov 1992, among others). However, the use of WF shapes as link beams necessitates that they be braced out-of-plane to prevent lateral torsional buckling. This requirement has limited their use in bridge piers where lateral bracing is difficult to provide. There have been some applications of EBF's with WF links in bridge piers for long span bridges such as the San Francisco-Oakland Bay Bridge and the Richmond-San Rafael Bridge (Dusicka et al. 2002, and Itani 1997). In these cases, either very short links were used or special considerations for link stability were made, which may have increased the cost of the projects. Therefore, a link type that does not require lateral bracing was recently developed (Berman and Bruneau 2005a, 2006). Such self-stabilizing Tubular Eccentric Braced Frames (TEBF) would also be useful in buildings where lateral bracing may not be feasible or easily provided (such as between two elevator shafts or along the façade of an open atrium). Specific design recommendations for tubular links in eccentrically braced frames were developed based on a proof-of-concept experiment, a finite element parametric study, and testing of links with various cross-sectional properties and lengths. A brief overview of the proof-of-concept tests follows. The reader is referred to (Berman and Bruneau 2005a, 2006) for complete details on all phases of this research.

To investigate the use of tubular cross-sections for links in EBFs where no lateral bracing of the link is provided, a proof-of-concept single story (or single panel in the context of a bridge pier) EBF was designed and quasi-statically tested. The test setup is shown in Fig. 10. As shown, a hydraulic actuator applied load to a loading beam that equally distributed the load to clevises at the top of each column. The frame was mounted on clevises at the base of each column that were fastened to a foundation beam that attached to a strong floor and also to the reaction frame where the actuator was mounted. For safety, the setup was laterally braced at two points on the loading beam by towers, however, no lateral bracing was provided to the link itself. Link design and derivation of the design equations are described in detail in Berman and Bruneau (2005b, 2006).

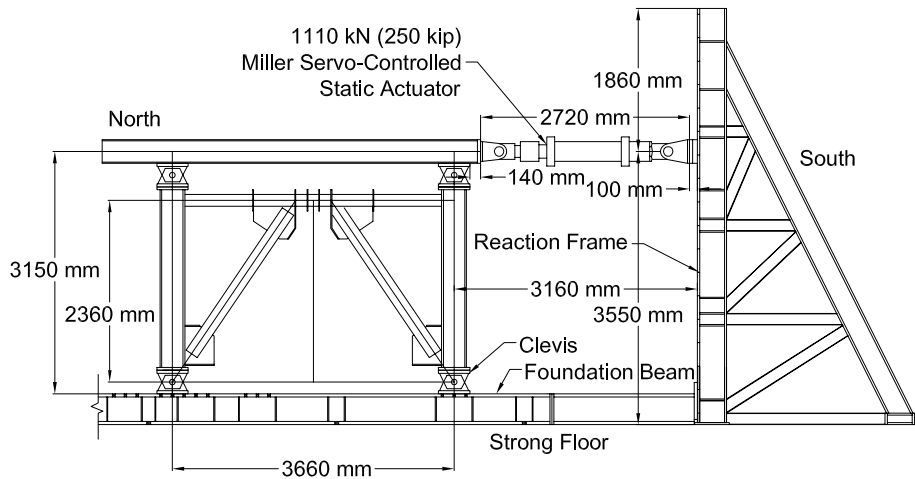

Figure 10. Proof-of-Concept Test Setup (Berman and Bruneau 2005b).

A quasi-static loading protocol used here was developed based on the guidelines presented in ATC-24 (ATC 1992). The link shear force versus rotation hysteresis curve is shown in Fig. 11a and a maximum rotation of 0.151 rads was achieved. The link shear at yield,  $V_{ye}$ , and corresponding yield rotation were 490 kN and 0.014 radians, while the maximum link shear was 742 kN at 0.151 radians (note that the maximum rotation for which a complete cycle was achieved was 0.123 rads). No evidence of lateral torsional buckling, web buckling or flange was observed and link -0.123 rads of rotation is shown in Fig. 11b. The failure mode was flange fracture at the maximum rotation of 0.151 rads. Fracture initiated in area adjacent to the fillet weld of the end stiffener to the bottom link flange and a full discussion of this failure mode is provided in Berman and Bruneau (2006).

The 2005 AISC Seismic Provisions (AISC 2005) classify links as shear, intermediate, or flexural according to their normalized link length,  $\rho$ , defined as  $e/(M_p/V_p)$ , where  $e$  is the link length. Links with  $\rho \leq 1.6$  are shear links that yield predominantly in shear and have a maximum link rotation under the design seismic loading of 0.08 rads. The link in the proof-of-concept test had a design normalized link length of 1.3 and sustained a complete cycle of loading at a rotation of 0.123 rads, significantly larger than the maximum allowed in the code. This indicates that tubular links without lateral bracing can achieve rotation levels comparable to those of WF links. Fifteen additional links with various normalized link lengths were tested and also demonstrated plastic rotation capacity meeting the AISC specified minimums.

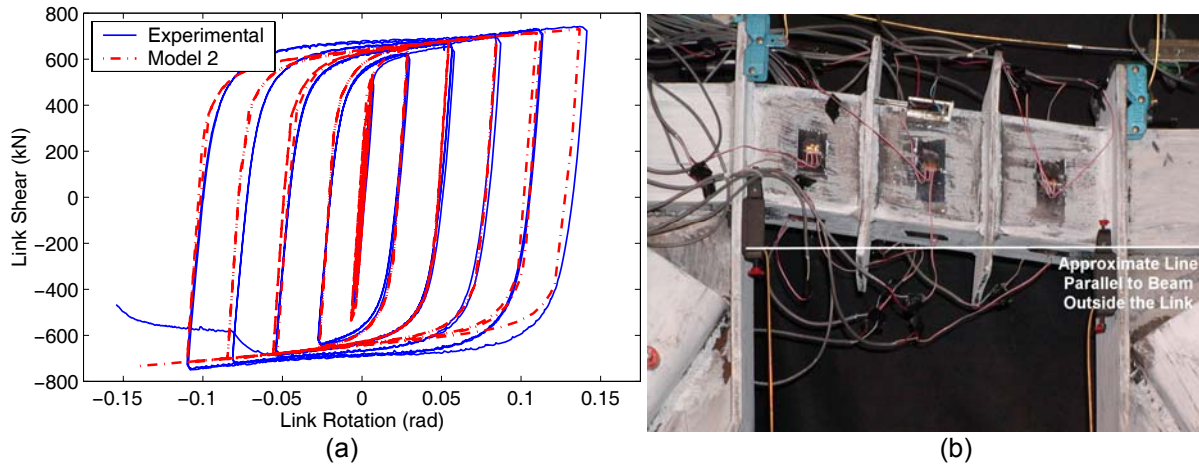

Figure 11. (a) Proof-of-Concept Link Hysteresis Curve; (b) Deformed Link at -0.123 rads (Berman and Bruneau 2005b).

### Rocking Truss Piers

Steel truss bridges are found in nearly every region of the U.S. Many existing steel truss bridges consist of riveted construction with built-up, lattice type members supporting a slab-on-girder bridge deck. Truss piers are typically in an X- or V-braced configuration. These built-up lattice type members and their connections can be the weak link in the seismic load path. Recent experimental testing (Fig. 12) of these members revealed the limited ductility that can be achieved due to global and local buckling causing significant strength and stiffness degradation (Lee and Bruneau 2004). Existing, riveted connections and deck diaphragm bracing members typically possess little to no ductility (Ritchie et al. 1999). Another possible non-ductile failure location is the anchorage connection at the pier-to-foundation interface. Analyses of “typical” steel-concrete connections suggests it may be unable to resist even moderate seismic demands.

While strengthening these existing vulnerable elements to resist seismic demands elastically is an option, this method can be expensive and also gives no assurance of performance beyond the elastic limit. Therefore it is desirable to have structures able to deform inelastically, limiting damage to easily replaceable, ductile structural “fuses” able to produce stable hysteretic behavior while protecting existing non-ductile elements and preventing residual deformations using a capacity-based design procedure.

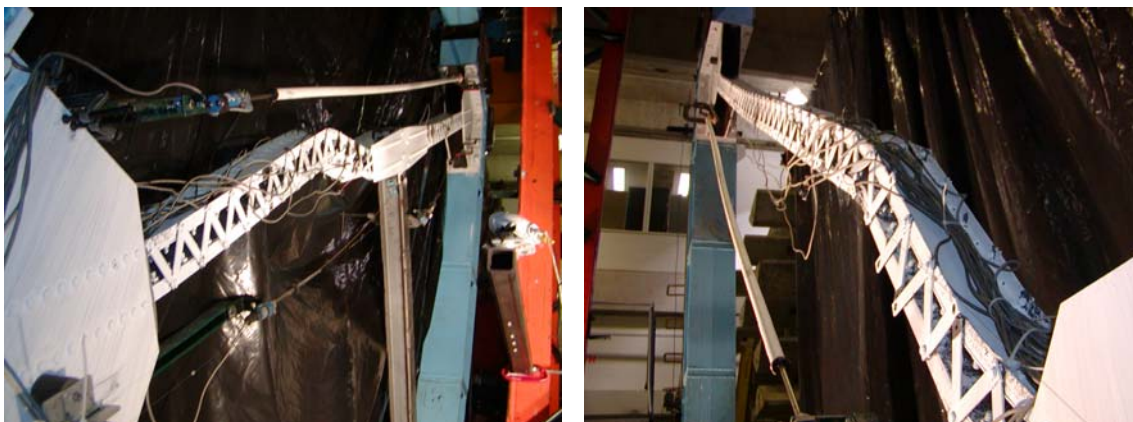

Figure 12. Global buckled shape of various specimens (Lee and Bruneau 2004).

Failure of, or releasing of, the anchorage connection allows a steel truss pier to rock on its foundation, partially isolating the pier. Addition of passive energy dissipation devices at the uplifting location can control the rocking response while providing energy dissipation (Pollino and Bruneau 2004; 2007). This system can also be designed to provide an inherent restoring force capability that allows for automatic re-centering of the tower, leaving the bridge with no residual displacements after an earthquake. The device used in this application is the unbonded brace. An unbonded brace is a type of Buckling Restrained Brace (BRB) and consists of a steel core surrounded by a restraining part, allowing the brace to reach full yield in tension and compression. Experimental testing of the braces can be found in Iwata et al. (2000). Also, this strategy limits the retrofit effort by working at a fairly accessible location. A sketch of a retrofitted bridge pier is shown in Fig. 13.

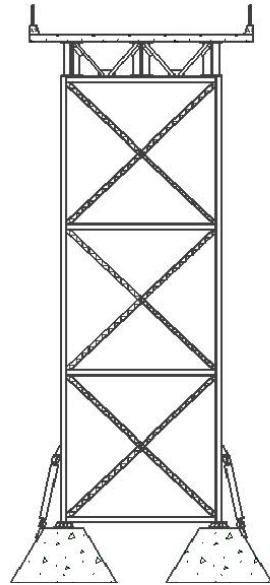

Figure 13. Sketch of retrofitted pier with Unbonded Braces (Pollino and Bruneau 2004).

A controlled rocking approach to seismic resistance was implemented into the design of the South Rangitikei Rail Bridge, Mangaweka, New Zealand in the early 1981 (Priestley et al. 1996) and was later used as a seismic retrofit technique in the Lions' Gate Bridge located in Vancouver, British Columbia (Dowdell and Hamersley 2001) as shown in Fig. 14. Both bridges use steel yielding devices across the anchorage interface for added energy dissipation.

The controlled rocking bridge pier system considered can be shown to develop a flag-shaped hysteresis similar to the self-centering systems described above. This is due to the combination of pure rocking response from the restoring moment provided by the bridge deck weight and energy dissipation provided by yielding of the unbonded braces. Hysteretic behavior in the 1st and subsequent cycles, for a given magnitude of inelastic deformation in the unbonded braces, is shown on a single plot in Fig. 15.





Figure 14. South Rangitikei Rail Bridge (Priestley et al. 1996) (left) and Lion's Gate Bridge- north approach (personal communication, Hamersley, B., Engineer, Klohn Crippen Berger 2002) (right).

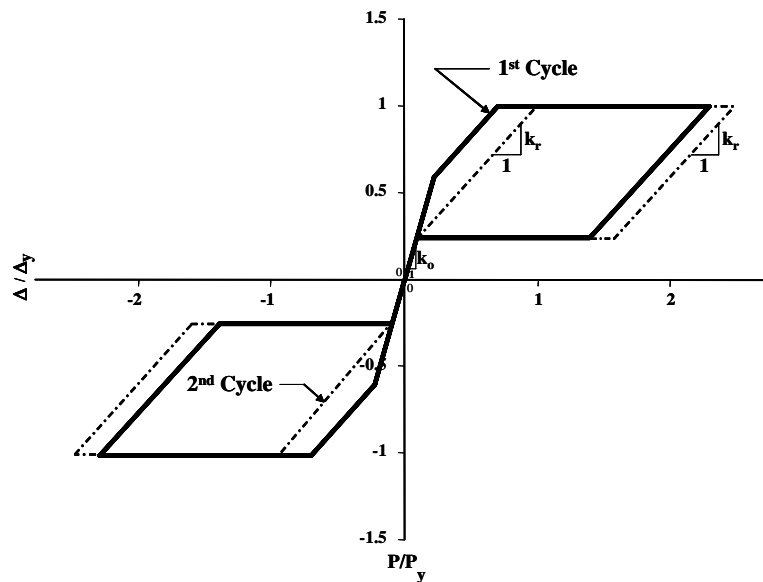

Figure 15. Hysteretic Behavior of Rocking Truss Pier (Pollino and Bruneau 2004).

A parametric study was undertaken in order to provide a preliminary understanding of system behavior. Results obtained were then used to assist in formulating a design procedure that can reliably predict the system's ultimate seismic response. In the perspective of seismic retrofit, a capacity based design procedure was also proposed to protect non-ductile elements while limiting energy dissipation to the specially detailed steel yielding devices. In a seismic retrofit perspective, a large number of constraints exist and thus a systematic design procedure that satisfies all constraints was developed. The proposed design procedure was complemented by a graphical approach in which the boundaries of compliance and non-compliance of the design constraints are plotted with respect to two key design parameters. The two design parameters used are the length and cross-sectional area of the unbonded brace,  $L_{ub}$  and  $A_{ub}$  respectively (Pollino and Bruneau 2004). At the time of this writing, a shake table testing program is

underway to verify and validate the proposed design procedure. Results from a first phase of testing, completed recently, confirm the adequacy of the proposed design procedure.

### Conclusions

Ultimately, research allows expanding the variety and versatility of the tools available in the structural engineer's toolbox to meet seismic performance objectives. As such, this brief paper provided an overview of some recently developed options for the seismic design and retrofit of steel building and bridges, focusing on innovations that expand the range of application of SPSW, BRB frames, and EBF frames, and provide a renewed interest in rocking structures.

### Acknowledgments

This research was supported in part by the Earthquake Engineering Research Centers Program of the National Science Foundation (NSF) under Award Number EEC-9701471 to the Multidisciplinary Center for Earthquake Engineering Research (MCEER), as well as by the Federal Highway Administration under contract number DTFH61-98-C-00094 to the Multidisciplinary Center for Earthquake Engineering Research. The author sincerely thanks Jeffery Berman (University of Washington, Seattle), Darren Vian (Parsons Brinckerhoff), Ramiro Vargas (Technological University of Panama), Michael Pollino (University at Buffalo) for the brief research summaries included in this paper. Any opinions, findings, conclusions, and recommendations presented in this paper are those of the writer and do not necessarily reflect the views of the sponsors.

### References

- American Institute of Steel Construction (AISC), 2005. *Seismic Provisions for Structural Steel Buildings*, Chicago, IL.
- Applied Technology Council (ATC), 1992. Guidelines for Seismic Testing of Components of Steel Structures, *Report-24*, Redwood City, CA.
- Berman, J.W. and Bruneau, M., 2006. Further Development of Tubular Eccentrically Braced Frame Links for the Seismic Retrofit of Braced Steel Truss Bridge Piers, *Technical Report MCEER-06-0006*, Multidisciplinary Center for Earthquake Engineering Research, Buffalo, NY.
- Berman, J.W. and Bruneau, M., 2005a. Supplemental System Retrofit Considerations for Braced Steel Bridge Piers, *J. of Earthquake Engineering and Structural Dynamics*, 34(4 and 5), 497-517.
- Berman, J.W. and Bruneau, M., 2005b. Approaches for the Seismic Retrofit of Braced Steel Bridge Piers and Proof-of-Concept Testing of a Laterally Stable Eccentrically Braced Frame, *Technical Report MCEER-05-0004*, Multidisciplinary Center for Earthquake Engineering Research, Buffalo, NY.
- Berman, J.W. and Bruneau, M., 2004. Steel Plate Shear Walls are Not Plate Girders, *Engineering Journal, AISC 41* (3), 95-106.
- Bruneau, M. and Berman, J., 2003a. Plastic Analysis and Design of Steel Plate Shear Walls, *ASCE Journal of Structural Engineering* 129 (11), 1448-1456.
- Berman, J.W. and Bruneau, M., 2003b. Experimental investigation of light-gauge steel plate shear walls for the seismic retrofit of buildings, *Tech. Rep. MCEER-03-0001*, Multidisciplinary Center for Earthquake Engineering Research, State University of New York at Buffalo, Buffalo, N.Y.
- Bruneau, M., Engelhardt, M., Filiatrault, A., Goel, S.C., Itani, A., Hajjar, J., Leon, R., Ricles, J., Stojadinovic, B. and Uang, C.M., 2005. Review of Selected Recent Research on Us Seismic Design and Retrofit Strategies for Steel Structures, *Journal of Progress in Structural Engineering and Materials*, 7, 103-114.



- Caccese, V., Elgaaly, M. and Chen, R., 1993. Experimental study of thin steel-plate shear walls under cyclic load, *ASCE Journal of Structural Engineering*, 573–587.
- Canadian Standards Association (CSA), 2001. .Limit States Design of Steel Structures, *CAN/CSA S16-01*, Willowdale, Ontario, Canada
- Dowdell, D. and Hamersley, B., 2001. Lions' Gate Bridge North Approach: Seismic Retrofit, Behaviour Steel Structures in Seismic Areas, *Proceedings of the Third International Conference: STESSA 2000*, Montreal, Canada, August 21-24, 2000, 319-326.
- Driver, R. G., Kulak, G. L., Kennedy, D. J. L. and Elwi, A. E., 1997. Seismic behavior of steel plate shear walls. *Structural Engineering Rep. No. 215*, Dept. of Civil Engineering, Univ. of Alberta, Edmonton, Alberta, Canada.
- Dusicka, P., Itani, A.M. and Buckle, I. G., 2002. Cyclic Behavior of Shear Links and Tower Shaft Assembly of San Francisco-Oakland Bay Bridge Tower. *Report No. CCEER 02-06*, Center for Civil Engineering Earthquake Research, University of Nevada, Reno, NV.
- Engelhardt, M. D. and Popov, E. P., 1992. Experimental Performance of Long Links in Eccentrically Braced Frames, *J. Struc. Eng.*, 118 (11), 3067-3088.
- Hjelmstad, K. D. and Popov, E. P., 1984. Characteristics of Eccentrically Braced Frames, *J. Struc. Eng.*, 110 (2), 340-353.
- Hjelmstad, K. D. and Popov, E. P., 1983. Cyclic Behavior and Design of Link Beams, *J. Struc. Eng.*, 109 (10), 2387-2403.
- Itani, A.M., 1997. Cyclic Behavior of Richmond-San Rafael Tower Links, *Technical Report CCEER 97-4*, Center for Civil Engineering Earthquake Research, University of Nevada Reno, Reno, NV.
- Iwata, M., Kato, T. and Wada, A., 2000. Buckling-restrained braces as hysteretic dampers, *Behaviour of Steel Structures in Seismic Areas*, STESSA 2000, 33-38.
- Kasai, K. and Popov, E. P., 1986a. Study of Seismically Resistant Eccentrically Braced Steel Frame Systems, *Report No. UCB/EERC-86/01*, Earthquake Engineering Research Center, College of Engineering, University of California Berkeley, Berkeley, CA.
- Kasai, K. and Popov, E.P., 1986b. General Behavior of WF Steel Shear Link Beams, *J. Struc. Eng.*, 112 (2), 362-382.
- Lee, K. and Bruneau, M., 2004. Seismic Vulnerability Evaluation of Axially Loaded Steel Built-up Laced Members, *Technical Report MCEER-04-0007*, Multidisciplinary Center for Earthquake Engineering Research, State University of New York at Buffalo, Buffalo, NY.
- López, W.A., Gwie, D.S., Saunders, M. and Lauck, T.W., 2002. Lessons learned from large-scale tests of unbonded braced frame subassembly, *Proceedings of the 71st Annual Convention of SEAOC*, Sacramento, CA, 171–183.
- Lopez-Garcia, D. and Bruneau, M., 2006. Seismic Behavior of Intermediate Beams in Steel Plate Shear Walls, *8th National Seismic Conference*, San Francisco, April 2006 - CD-ROM Paper No. 1089.
- Lubell, A.S., Prion, H.G.L., Ventura, C.E. and Rezai, M., 2000. Unstiffened steel plate shear wall performance under cyclic loading. *ASCE Journal of Structural Engineering*, 453–460
- Mahin, S.A., Uriz, P., Aiken, I., Field, C. and Ko, E., 2004. Seismic Performance of Buckling Restrained Brace Frame Systems, *Proceedings of 13th World Conference on Earthquake Engineering*, Paper No. 1681. Vancouver, B.C., Canada.
- Malley, J.O. and Popov, E.P., 1984. Shear Links in Eccentrically Braced Frames, *J. Struc. Eng.*, 110 (9), 2275-2295.

- Pollino, M. and Bruneau, M., 2004. Seismic Retrofit of Bridge Steel Truss Piers Using a Controlled Rocking Approach, *Technical Report MCEER-04-0011*, Multidisciplinary Center for Earthquake Engineering Research, The State University of New York at Buffalo, Buffalo, NY.
- Pollino, M. and Bruneau, M. (2007). "Seismic Retrofit of Bridge Steel Truss Piers Using a Controlled Rocking Approach." *J. Bridge Eng.* ASCE, (in press 2007).
- Popov, E.P. and Bertero, V.V., 1980. Seismic Analysis of Some Steel Building Frames, *J. of the Eng., Mech. Div.*, 106 (1), 75-92.
- Priestley, M.J.N., Seible, F. and Calvi, G.M., 1996. *Seismic Design and Retrofit of Bridges*, John Wiley & Sons, New York.
- Ricles, J.M. and Popov, E.P., 1989. Composite Action in Eccentrically Braced Frames, *J. Struc. Eng.*, 115 (8), 2046-2066.
- Ritchie, P., Kauh., N. and Kulicki, J., 1999. Critical Seismic Issues for Existing Steel Bridges, *Technical Report MCEER-99-0013*, Multidisciplinary Center for Earthquake Engineering Research, State University of New York at Buffalo, Buffalo, NY.
- Roeder, C.W. and Popov, E.P., 1978a. Eccentrically Braced Steel Frames for Earthquakes, *J. Struc. Eng.*, 104 (3), pp. 391-412.
- Roeder, C.W. and Popov, E.P., 1978b. Cyclic Shear Yielding of Wide-Flange Beams, *J. of the Eng. Mech. Div.*, 104 (4), 763-780.
- Sabelli, R., Mahin, S.A. and Chang, C., 2003. Seismic demands on steel braced-frame buildings with buckling-restrained braces, *Engineering Structures*, 25, 655-666.
- Thorburn, L. J., Kulak, G. L. and Montgomery, C. J., 1983. Analysis of steel plate shear walls, *Structural Engineering Rep. No. 107*, Dept. of Civil Engineering, Univ. of Alberta, Edmonton, Alberta, Canada.
- Tsai, K.C., Hsiao, P.C., Lai, J.W., Weng, Y.T., Lin, M.L. and Chen, C.H., 2004. International Collaboration on Pseudo-Dynamic Tests of a Full Scale BRB Composite Frame, *Workshop of the Asian-Pacific Network of Center in Earthquake Engineering Research*, Honolulu, July 2004 - CD-ROM.
- Uang, C.M. and Nakashima, M., 2003. Steel buckling-restrained braced frames. Chapter 16, *Earthquake Engineering: Recent Advances and Applications*, CRC Press, Boca Raton, FL.
- Uriz, P., 2005. Towards Earthquake Resistant Design of Concentrically Braced Steel Buildings, *Ph.D. Dissertation*, University of California, Berkeley.
- Vargas, R. and Bruneau, M., 2006a. Experimental Investigation of the Structural Fuse Concept, *Technical Report MCEER-06-0005*, Multidisciplinary Center for Earthquake Engineering Research, State University of New York at Buffalo, Buffalo, NY, 2006.
- Vargas, R. and Bruneau, M., 2006b. Analytical Investigation of the Structural Fuse Concept, *Technical Report MCEER-06-0004*, Multidisciplinary Center for Earthquake Engineering Research, State University of New York at Buffalo, Buffalo, NY, 2006.
- Vian, D. and Bruneau, M., 2004. Testing of Special LYS Steel Plate Shear Walls, *13th World Conference on Earthquake Engineering*, Vancouver, Canada, Paper No. 978.
- Yang, T.Y. and Whittaker, A.S., 2000. MCEER Demonstration Hospitals – Mathematical Models and Preliminary Results, *Technical Report*, Multidisciplinary Center for Earthquake Engineering Research, University at Buffalo, Buffalo, NY.